



**Technical and Test Institute  
for Construction Prague**  
Prosecká 811/76a  
190 00 Prague  
Czech Republic  
eota@tzus.cz



Member of



www.eota.eu

## European Technical Assessment

**ETA 17/0377  
of 13/07/2017**

(English language translation, the original version in Czech language)

**Technical Assessment Body issuing the ETA:** Technical and Test Institute  
for Construction Prague

**Trade name of the construction product**

Fix Master FIT-Pe 270  
Fix Master FIT-Px 270  
Fix Master FIT-Pt 270

**Product family to which the construction  
product belongs**

Product area code: 33  
Bonded injection type anchor for use in  
non-cracked concrete

**Manufacturer**

Ferrometal Oy  
Karhutie 9  
FI-01900 Nurmijärvi  
Finland

**Manufacturing plant(s)**

Plant 1, Finland

**This European Technical Assessment  
contains**

15 pages including 11 Annexes which form  
an integral part of this assessment.

**This European Technical Assessment is  
issued in accordance with regulation  
(EU) No 305/2011, on the basis of**

ETAG 001-Part 1 and Part 5, edition 2013,  
used as European Assessment Document  
(EAD)

Translations of this European Technical Assessment in other languages shall fully correspond to the original issued document and should be identified as such.

Communication of this European Technical Assessment, including transmission by electronic means, shall be in full (excepted the confidential Annex(es) referred to above). However, partial reproduction may be made, with the written consent of the issuing Technical Assessment Body - Technical and Test Institute for Construction Prague. Any partial reproduction has to be identified as such

## 1. Technical description of the product

The Fix Master FIT-Pe 270, FIT-Px 270, FIT-Pt 270 polyester resin styrene-free for non-cracked concrete is a bonded anchor consisting of a cartridge with injection mortar and a steel element. The steel elements consists of a commercial threaded rods, a hexagon nut and a washer. The steel elements are made of galvanized steel or stainless steel.

The steel element is placed into a drilled hole filled with injection mortar and is anchored via the bond between metal part, injection mortar and concrete.

The illustration and the description of the product are given in Annex A.

## 2. Specification of the intended use in accordance with the applicable EAD

The performances given in Section 3 are only valid if the anchor is used in compliance with the specifications and conditions given in Annex B.

The provisions made in this European Technical Assessment are based on an assumed working life of the anchor of 50 years. The indications given on the working life cannot be interpreted as a guarantee given by the producer, but are to be regarded only as a means for choosing the products in relation to the expected economically reasonable working life of the works.

## 3. Performance of the product and references to the methods used for its assessment

### 3.1 Mechanical resistance and stability (BWR 1)

Essential characteristic	Performance
Characteristic resistance for tension loads	See Annex C 1
Characteristic resistance for shear loads	See Annex C 2
Displacement	See Annex C 3

### 3.2 Safety in case of fire (BWR 2)

Essential characteristic	Performance
Reaction to fire	Anchorage satisfy requirements for Class A1
Resistance to fire	No performance assessed

### 3.3 Hygiene, health and environment (BWR 3)

Regarding dangerous substances contained in this European Technical Assessment, there may be requirements applicable to the products falling within its scope (e.g. transposed European legislation and national laws, regulations and administrative provisions). In order to meet the provisions of the Regulation (EU) No 305/2011, these requirements need also to be complied with, when and where they apply.

### 3.4 Safety in use (BWR 4)

For basic requirement safety in use the same criteria are valid as for Basic Requirement Mechanical resistance and stability.

### 3.5 Sustainable use of natural resources (BWR 7)

For the sustainable use of natural resources no performance was determined for this product.

### 3.6 General aspects relating to fitness for use

Durability and serviceability are only ensured if the specifications of intended use according to Annex B 1 are kept.

#### 4. **Assessment and verification of constancy of performance (AVCP) system applied with reference to its legal base**

According to the Decision 96/582/EC of the European Commission<sup>1</sup> the system of assessment verification of constancy of performance (see Annex V to Regulation (EU) No 305/2011) given in the following table applies.

<b>Product</b>	<b>Intended use</b>	<b>Level or class</b>	<b>System</b>
Metal anchors for use in concrete	For fixing and/or supporting to concrete, structural elements (which contributes to the stability of the construction works) or heavy units	-	1

#### 5. **Technical details necessary for the implementation of the AVCP system, as provided in the applicable EAD**

##### 5.1 **Tasks of the manufacturer**

The manufacturer shall exercise permanent internal control of production. All the elements, requirements and provisions adopted by the manufacturer shall be documented in a systematic manner in the form of written policies and procedures, including records of results performed. This production control system shall insure that the product is in conformity with this European Technical Assessment.

The manufacturer may only use raw materials stated in the technical documentation of this European Technical Assessment.

The factory production control shall be in accordance with the control plan which is a part of the technical documentation of this European Technical Assessment. The control plan is laid down in the context of the factory production control system operated by the manufacturer and deposited at Technický a zkušební ústav stavební Praha, s.p.<sup>2</sup> The results of factory production control shall be recorded and evaluated in accordance with the provisions of the control plan.

The manufacturer shall, on the basis of a contract, involve a body which is notified for the tasks referred to in section 4 in the field of anchors in order to undertake the actions laid down in section 5.2. For this purpose, the control plan referred to in this section and section 5.2 shall be handed over by the manufacturer to the notified body involved.

The manufacturer shall make a declaration of performance, stating that the construction product is in conformity with the provisions of this European Technical Assessment.

---

<sup>1</sup> Official Journal of the European Communities L 254 of 08.10.1996

<sup>2</sup> The control plan is a confidential part of the documentation of the European Technical Assessment, but not published together with the ETA and only handed over to the approved body involved in the procedure of AVCP.

## **5.2 Tasks of the notified bodies**

The notified body shall retain the essential points of its actions referred to above and state the results obtained and conclusions drawn in a written report.

The notified certification body involved by the manufacturer shall issue a certificate of constancy of performance of the product stating the conformity with the provisions of this European Technical assessment.

In cases where the provisions of the European Technical Assessment and its control plan are no longer fulfilled the notified body shall withdraw the certificate of constancy of performance and inform Technický a zkušební ústav stavební Praha, s.p without delay.

Issued in Prague on 13.07.2017

By

**Ing. Mária Schaan**

Head of the Technical Assessment Body

### Installation threaded rod

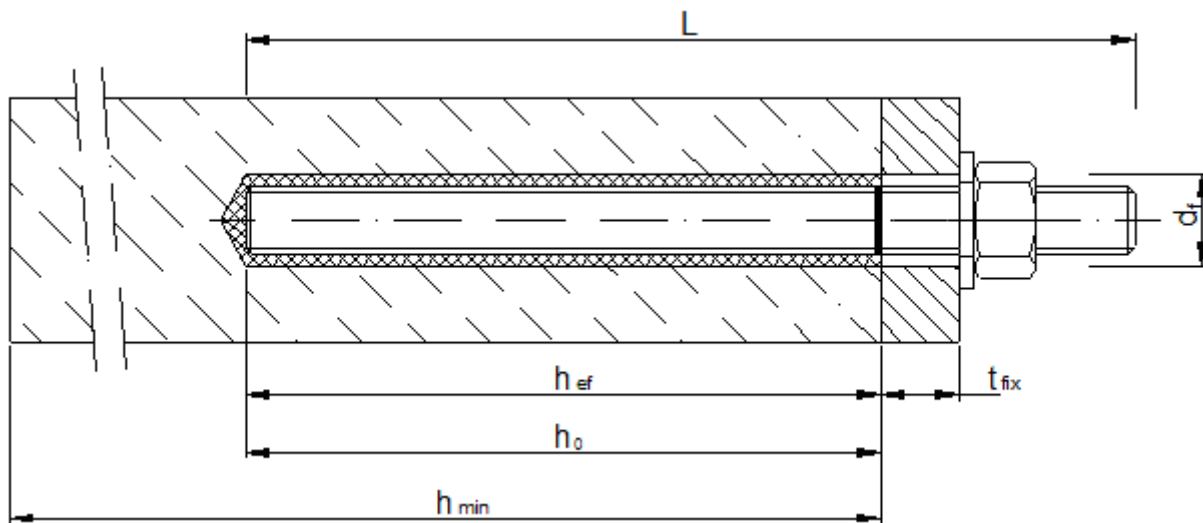

- $d_f$  = diameter of clearance hole in the fixture
- $t_{fix}$  = thickness of fixture
- $h_{ef}$  = effective embedment depth
- $h_o$  = depth of drill hole
- $h_{min}$  = minimum thickness of member

**Injection system for concrete**  
**Fix Master FIT-Pe 270, Fix Master FIT-Px 270, Fix Master FIT-Pt 270**

**Product description**  
 Installed conditions

**Annex A 1**

**Cartridge: Fix Master FIT-Pe 270, Fix Master FIT-Px 270, Fix Master FIT-Pt 270**

**150 ml, 280 ml, 300 ml up to 330 ml and 380 ml up to 420 ml cartridge (Type: coaxial)**

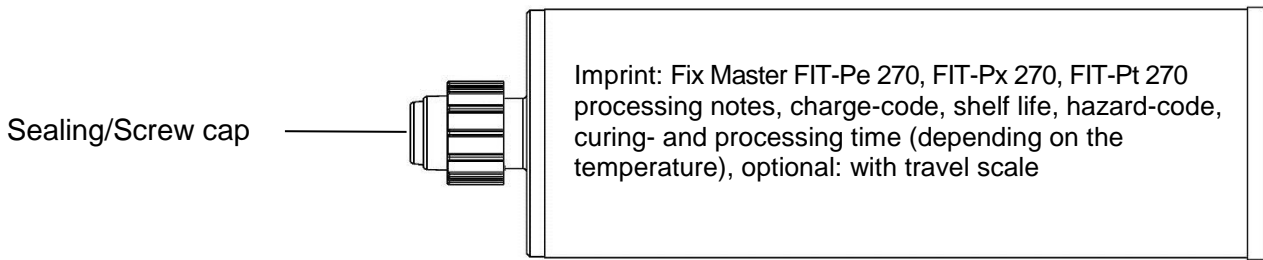

**235 ml, 345 ml up to 360 ml and 825 ml cartridge (Type: "side-by-side")**

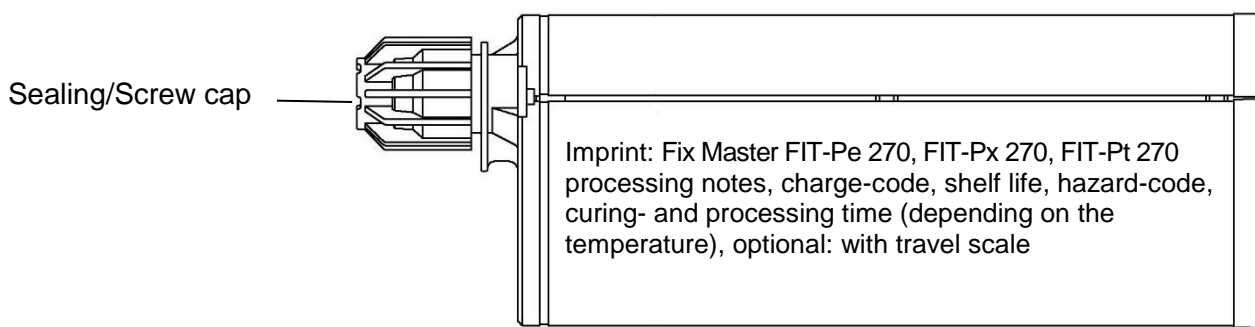

**165 ml and 300 ml cartridge (Type: "foil tube")**

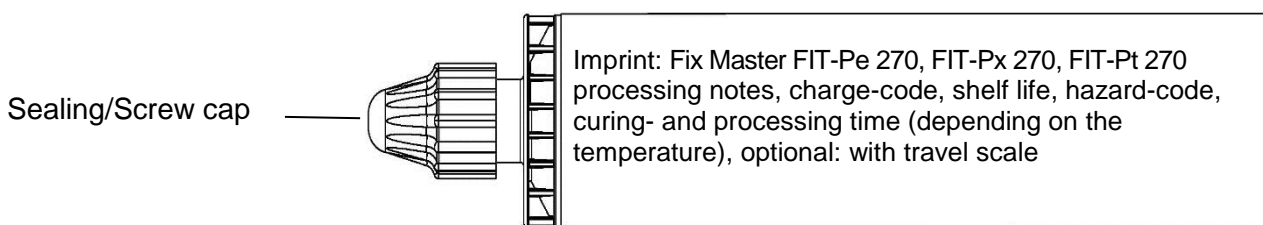

**Static mixer**

SM 14W



CM 8W



**Injection system for concrete**  
**Fix Master FIT-Pe 270, Fix Master FIT-Px 270, Fix Master FIT-Pt 270**

**Product description**  
 Injection system

**Annex A 2**

**Threaded rod M8, M10, M12, M16, M20, M24 with washer and hexagon nut**

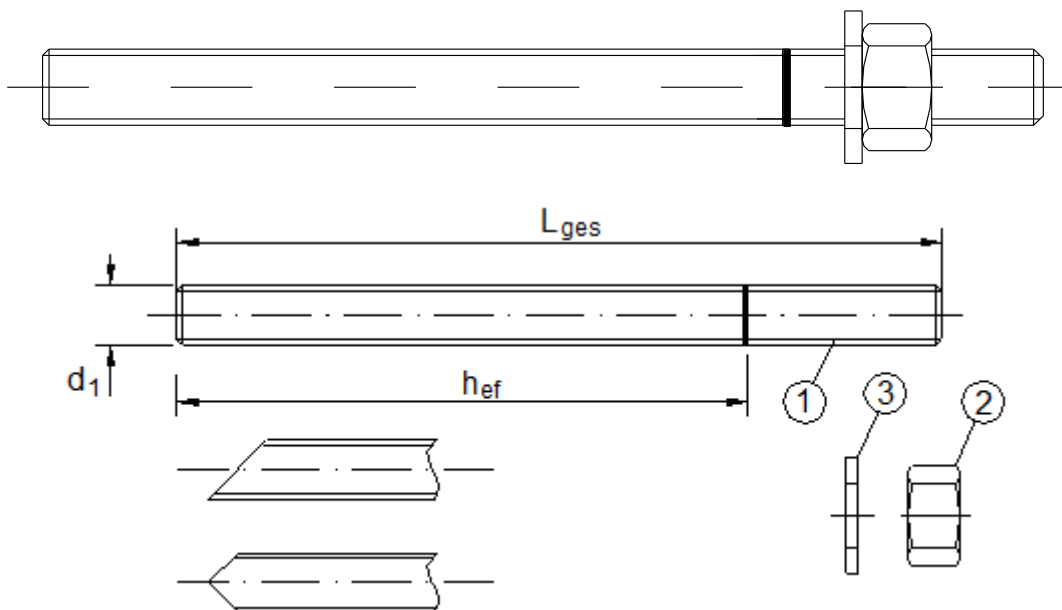

Commercial standard threaded rod with:

- Materials, dimensions and mechanical properties acc. Table A1
- Inspection certificate 3.1 acc. to EN 10204:2004
- Marking of embedment depth

**Injection system for concrete**  
**Fix Master FIT-Pe 270, Fix Master FIT-Px 270, Fix Master FIT-Pt 270**

**Product description**  
 Threaded rod

**Annex A 3**

<b>Table A1: Materials</b>		
<b>Part</b>	<b>Designation</b>	<b>Material</b>
<b>Steel, zinc plated <math>\geq 5 \mu\text{m}</math> acc. to EN ISO 4042:1999 or Steel, hot-dip galvanised <math>\geq 40 \mu\text{m}</math> acc. to EN ISO 1461:2009 and EN ISO 10684:2004+AC:2009</b>		
1	Anchor rod	Steel, EN 10087:1998 or EN 10263:2001 Property class 4.6, 4.8, 5.8, 8.8, EN 1993-1-8:2005+AC:2009
2	Hexagon nut, EN ISO 4032:2012	Steel acc. to EN 10087:1998 or EN 10263:2001 Property class 4 (for class 4.6 or 4.8 rod) EN ISO 898-2:2012, Property class 5 (for class 5.8 rod) EN ISO 898-2:2012, Property class 8 (for class 8.8 rod) EN ISO 898-2:2012
3	Washer, EN ISO 887:2006, EN ISO 7089:2000, EN ISO 7093:2000 or EN ISO 7094:2000	Steel, zinc plated or hot-dip galvanised
<b>Stainless steel</b>		
1	Anchor rod	Material 1.4401 / 1.4404 / 1.4571, EN 10088-1:2005, Property class 70 EN ISO 3506-1:2009
2	Hexagon nut, EN ISO 4032:2012	Material 1.4401 / 1.4404 / 1.4571 EN 10088-1:2005, Property class 70 (for class 70 rod) EN ISO 3506-2:2009
3	Washer, EN ISO 887:2006, EN ISO 7089:2000, EN ISO 7093:2000 or EN ISO 7094:2000	Material 1.4401, 1.4404 or 1.4571, EN 10088-1:2005
<b>High corrosion resistant steel</b>		
1	Anchor rod	Material 1.4529 / 1.4565, EN 10088-1:2005, Property class 70 EN ISO 3506-1:2009
2	Hexagon nut, EN ISO 4032:2012	Material 1.4529 / 1.4565 EN 10088-1:2005, Property class 70 (for class 70 rod) EN ISO 3506-2:2009
3	Washer, EN ISO 887:2006, EN ISO 7089:2000, EN ISO 7093:2000 or EN ISO 7094:2000	Material 1.4529 / 1.4565, EN 10088-1:2005
<b>Injection system for concrete Fix Master FIT-Pe 270, Fix Master FIT-Px 270, Fix Master FIT-Pt 270</b>		
<b>Product description</b> Materials		<b>Annex A 4</b>



## Specifications of intended use

### Anchorage subject to:

- Static and quasi-static loads

### Base materials:

- Reinforced or unreinforced normal weight concrete according to EN 206-1:2000.
- Strength classes C20/25 to C50/60 according to EN 206-1:2000.
- Non-cracked concrete

### Temperature range:

- I: - 40 °C to +40 °C (max long term temperature +24 °C and max short term temperature +40 °C)
- II: - 40 °C to +80 °C (max long term temperature +50 °C and max short term temperature +80 °C)

### Use conditions (Environmental conditions):

- Structures subject to dry internal conditions (zinc coated steel, stainless steel or high corrosion resistant steel).
- Structures subject to external atmospheric exposure (including industrial and marine environment) and to permanently damp internal condition, if no particular aggressive conditions exist (stainless steel or high corrosion resistant steel).
- Structures subject to external atmospheric exposure and to permanently damp internal condition, if other particular aggressive conditions exist (high corrosion resistant steel).

Note: Particular aggressive conditions are e.g. permanent, alternating immersion in seawater or the splash zone of seawater, chloride atmosphere of indoor swimming pools or atmosphere with extreme chemical pollution (e.g. in desulphurization plants or road tunnels where de-icing materials are used).

### Design:

- Verifiable calculation notes and drawings are prepared taking account of the loads to be anchored. The position of the anchor is indicated on the design drawings (e. g. position of the anchor relative to reinforcement or to supports, etc.).
- Anchorages are designed under the responsibility of an engineer experienced in anchorages and concrete work.
- Anchorages under static or quasi-static actions are designed in accordance with:
  - EOTA Technical Report TR 029 "Design of bonded anchors", Edition September 2010 or
  - CEN/TS 1992-4:2009

### Installation:

- Dry or wet or flooded holes concrete.
- Hole drilling by hammer or compressed air drill mode.
- Overhead installation allowed.
- Anchor installation carried out by appropriately qualified personnel and under the supervision of the person responsible for technical matters of the site
- 

**Injection system for concrete**  
**Fix Master FIT-Pe 270, Fix Master FIT-Px 270, Fix Master FIT-Pt 270**

**Intended use**  
Specifications

**Annex B 1**

**Table B1: Installation parameters for threaded rod**

Anchor size		M 8	M 10	M 12	M 16	M 20	M 24
Nominal drill hole diameter	$d_0$ [mm] =	10	12	14	18	24	28
Effective anchorage depth	$h_{ef,min}$ [mm] =	60	60	70	80	90	96
	$h_{ef,max}$ [mm] =	160	200	240	320	400	480
Diameter of clearance hole in the fixture	$d_f$ [mm] ≤	9	12	14	18	22	26
Diameter of steel brush	$d_b$ [mm] ≥	12	14	16	20	26	30
Torque moment	$T_{inst}$ [Nm] ≤	10	20	40	80	120	160
Thickness of fixture	$t_{fix,min}$ [mm] >	0					
	$t_{fix,max}$ [mm] <	1500					
Minimum thickness of member	$h_{min}$ [mm]	$h_{ef} + 30$ mm ≥ 100 mm			$h_{ef} + 2d_0$		
Minimum spacing	$s_{min}$ [mm]	40	50	60	80	100	120
Minimum edge distance	$c_{min}$ [mm]	40	50	60	80	100	120

**Steel brush**

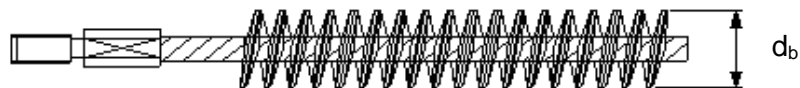

**Table B2: Parameter cleaning and setting tools**

Threaded Rod	$d_0$ Drill bit - Ø	$d_b$ Brush - Ø	$d_{b,min}$ min. Brush - Ø
(mm)	(mm)	(mm)	(mm)
M8	10	12	10,5
M10	12	14	12,5
M12	14	16	14,5
M16	18	20	18,5
M20	24	26	24,5
M24	28	30	28,5



**Hand pump (volume 750 ml)**  
Drill bit diameter ( $d_0$ ): 10 mm to 20 mm  
and anchorage depth up to 240 mm



**Recommended compressed air tool (min 6 bar)**  
All applications

**Injection system for concrete**  
**Fix Master FIT-Pe 270, Fix Master FIT-Px 270, Fix Master FIT-Pt 270**

**Intended use**  
Installation parameters  
Cleaning and setting tools

**Annex B 2**

## Installation instructions

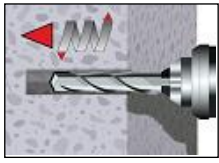

- 1 Drill with hammer drill a hole into the base material to the size and embedment depth required by the selected anchor (Table B1). In case of aborted drill hole: the drill hole shall be filled with mortar.

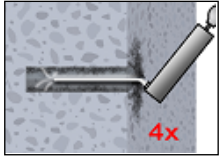

- Attention! Standing water in the bore hole must be removed before cleaning.**
- 2a Starting from the bottom or back of the bore hole, blow the hole clean with compressed air (min. 6 bar) or a hand pump (Annex B2) a minimum of four times. If the bore hole ground is not reached an extension shall be used.

or

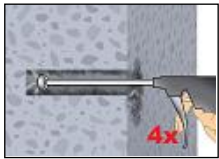

The hand-pump can be used for anchor sizes up to bore hole diameter 20 mm.

For bore holes larger than 20 mm or deeper 240 mm, compressed air (min. 6 bar) **must** be used.

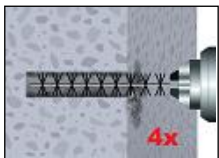

- 2b Check brush diameter (Table B2) and attach the brush to a drilling machine or a battery screwdriver. Brush the hole with an appropriate sized wire brush  $> d_{b,min}$  (Table B2) a minimum of four times. If the bore hole ground is not reached with the brush, a brush extension shall be used (Table B2).

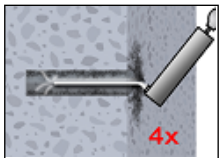

- 2c Finally blow the hole clean again with compressed air (min. 6 bar) or a hand pump (Annex B2) a minimum of four times. If the bore hole ground is not reached an extension shall be used.

The hand-pump can be used for anchor sizes up to bore hole diameter 20 mm.

For bore holes larger than 20 mm or deeper 240 mm, compressed air (min. 6 bar) **must** be used.

or



**After cleaning, the bore hole has to be protected against re-contamination in an appropriate way, until dispensing the mortar in the bore hole. If necessary, the cleaning repeated has to be directly before dispensing the mortar. In-flowing water must not contaminate the bore hole again**

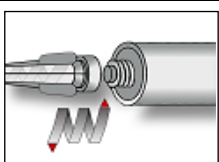

3. Attach a supplied static-mixing nozzle to the cartridge and load the cartridge into the correct dispensing tool. Cut off the foil tube clip before use. For every working interruption longer than the recommended working time (Table B3) as well as for new cartridges, a new static-mixer shall be used.

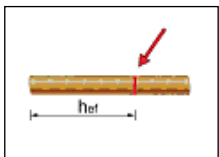

4. Prior to inserting the anchor rod into the filled bore hole, the position of the embedment depth shall be marked on the anchor rods.

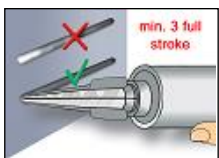

5. Prior to dispensing into the drill hole, squeeze out separately a minimum of three full strokes and discard non-uniformly mixed adhesive components until the mortar shows a consistent grey colour. For foil tube cartridges it must be discarded a minimum of six full strokes.

**Injection system for concrete**  
**Fix Master FIT-Pe 270, Fix Master FIT-Px 270, Fix Master FIT-Pt 270**

**Intended use**  
 Installation instructions

**Annex B 3**

## Installation instructions (continuation)

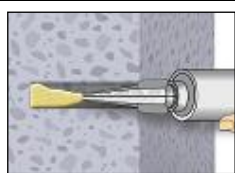

6. Starting from the bottom or back of the cleaned anchor hole fill the hole up to approximately two-thirds with adhesive. Slowly withdraw the static mixing nozzle as the hole fills to avoid creating air pockets. For embedment larger than 190 mm an extension nozzle shall be used. Observe the gel-/ working times given in Table B3.

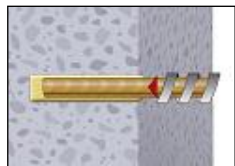

7. Push the threaded rod into the anchor hole while turning slightly to ensure positive distribution of the adhesive until the embedment depth is reached.

The anchor should be free of dirt, grease, oil or other foreign material.

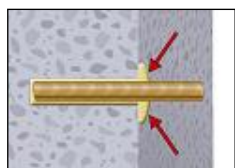

8. Be sure that the anchor is fully seated at the bottom of the hole and that excess mortar is visible at the top of the hole. If these requirements are not maintained, the application has to be renewed. For overhead application the anchor rod should be fixed (e.g. wedges).

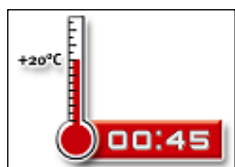

9. Allow the adhesive to cure to the specified time prior to applying any load or torque. Do not move or load the anchor until it is fully cured (attend Table B3).



10. After full curing, the add-on part can be installed with the max. torque (Table B1) by using a calibrated torque wrench.

**Table B3: Minimum curing time**

Concrete temperature [°C]	Fix Master FIT-Pt 270		Fix Master FIT-Pe 270		Fix Master FIT-Px 270	
	working time [min]	minimum curing time [min]	working time [min]	minimum curing time [min]	working time [min]	minimum curing time [min]
-10 to -6					60	240
-5 to -1			90	360	45	120
0 to +4			45	180	25	80
+5 to +9			25	120	10	45
+10 to +14	30	300	20	100	4	25
+15 to +19	20	210	15	80	3	20
+20 to +29	15	145	6	45	2	15
+30 to +34	10	80	4	25		
+35 to +39	6	45	2	20		
+40 to +44	4	25				
+45	2	20				
<b>Cartridge temperature</b>	<b>+5°C to +45°C</b>		<b>+5°C to +40°C</b>		<b>-5°C to +30°C</b>	

**Injection system for concrete**  
**Fix Master FIT-Pe 270, Fix Master FIT-Px 270, Fix Master FIT-Pt 270**

**Intended use**  
 Installation instructions (continuation)  
 Curing time

**Annex B 4**

**Table C1: Characteristic values under tension loads in non-cracked concrete**

Anchor size threaded rod		M 8	M 10	M 12	M 16	M 20	M 24		
<b>Steel failure</b>									
Characteristic tension resistance	$N_{Rk,s}$	[kN]	$A_s \times f_{uk}$						
<b>Combined pull-out and concrete failure</b>									
Characteristic bond resistance in non-cracked concrete C20/25									
Temperature range I: 40°C/24°C	dry and wet concrete	$\tau_{Rk,ucr}$	[N/mm <sup>2</sup> ]	8,5	8,0	8,0	8,0	8,0	8,0
	flooded bore hole	$\tau_{Rk,ucr}$	[N/mm <sup>2</sup> ]	8,5	8,0	8,0	8,0	8,0	8,0
Temperature range II: 80°C/50°C	dry and wet concrete	$\tau_{Rk,ucr}$	[N/mm <sup>2</sup> ]	6,5	6,0	6,0	6,0	6,0	6,0
	flooded bore hole	$\tau_{Rk,ucr}$	[N/mm <sup>2</sup> ]	6,5	6,0	6,0	6,0	6,0	6,0
Increasing factors for concrete $\psi_c$	C25/30		1,04						
	C30/37		1,08						
	C35/45		1,13						
	C40/50		1,15						
	C45/55		1,17						
	C50/60		1,19						
Factor according to CEN/TS 1992-4-5 Section 6.2.2.3	$k_8$	[-]	10,1						
<b>Concrete cone failure</b>									
Factor according to CEN/TS 1992-4-5 Section 6.2.3.1	$k_{ucr}$	[-]	10,1						
Edge distance	$c_{cr,N}$	[mm]	1,5 $h_{ef}$						
Axial distance	$s_{cr,N}$	[mm]	3,0 $h_{ef}$						
<b>Splitting failure</b>									
Edge distance	$h/h_{ef} \geq 2,0$	$c_{cr,sp}$	[mm]	1,0 $h_{ef}$					
	$2,0 > h/h_{ef} > 1,3$			$2 \cdot h_{ef} \left( 2,5 - \frac{h}{h_{ef}} \right)$					
	$h/h_{ef} \leq 1,3$			2,4 $h_{ef}$					
Axial distance	$s_{cr,sp}$	[mm]	2 $c_{cr,sp}$						
Installation safety factor (dry and wet concrete)	$\gamma_2 = \gamma_{inst}$	[-]	1,2						
Installation safety factor (flooded bore hole)	$\gamma_2 = \gamma_{inst}$	[-]	1,2						
<b>Injection system for concrete</b> <b>Fix Master FIT-Pe 270, Fix Master FIT-Px 270, Fix Master FIT-Pt 270</b>							<b>Annex C 1</b>		
<b>Performances</b> Characteristic values under tension loads in non-cracked concrete									

**Table C2: Characteristic values under shear loads in non-cracked concrete**

Anchor size threaded rod		M 8	M 10	M 12	M 16	M 20	M24	
<b>Steel failure without lever arm</b>								
Characteristic shear resistance,	$V_{Rk,s}$	[kN]	$0,5 \times A_s \times f_{uk}$					
Ductility factor according to CEN/TS 1992-4-5 Section 6.3.2.1	$k_2$	[-]	0,8					
<b>Steel failure with lever arm</b>								
Characteristic bending moment,	$M^0_{Rk,s}$	[Nm]	$1.2 \times W_{el} \times f_{uk}$					
<b>Concrete pry-out failure</b>								
Factor $k_3$ in equation (27) of CEN/TS 1992-4-5 Section 6.3.3 Factor $k$ in equation (5.7) of Technical Report TR 029	$k_{(3)}$	[-]	2,0					
Installation safety factor	$\gamma_2 = \gamma_{inst}$	[-]	1,0					
<b>Concrete edge failure</b>								
Effective length of anchor	$l_f$	[mm]	$l_f = \min(h_{ef}; 8 d_{nom})$					
Outside diameter of anchor	$d_{nom}$	[mm]	8	10	12	16	20	24
Installation safety factor	$\gamma_2 = \gamma_{inst}$	[-]	1,0					
<b>Injection system for concrete</b> <b>Fix Master FIT-Pe 270, Fix Master FIT-Px 270, Fix Master FIT-Pt 270</b>						<b>Annex C 2</b>		
<b>Performances</b> Characteristic values under shear loads in non-cracked concrete								

**Table C3: Displacement under tension load<sup>1)</sup>**

Anchor size threaded rod			M 8	M 10	M 12	M 16	M 20	M24
<b>Non-cracked concrete C20/25</b>								
Temperature range I: 40°C/24°C	$\delta_{N0}$ -factor	[mm/(N/mm <sup>2</sup> )]	0,03	0,04	0,05	0,07	0,08	0,10
	$\delta_{N\infty}$ -factor	[mm/(N/mm <sup>2</sup> )]	0,07	0,08	0,08	0,08	0,08	0,10
Temperature range II: 80°C/50°C	$\delta_{N0}$ -factor	[mm/(N/mm <sup>2</sup> )]	0,02	0,03	0,03	0,04	0,04	0,05
	$\delta_{N\infty}$ -factor	[mm/(N/mm <sup>2</sup> )]	0,15	0,17	0,17	0,17	0,17	0,17

<sup>1)</sup> Calculation of the displacement

$$\delta_{N0} = \delta_{N0\text{-factor}} \cdot \tau;$$

$$\delta_{N\infty} = \delta_{N\infty\text{-factor}} \cdot \tau;$$

**Table C4: Displacement under shear load<sup>1)</sup>**

Anchor size threaded rod			M 8	M 10	M 12	M 16	M 20	M24
<b>For non-cracked concrete C20/25</b>								
All temperature ranges	$\delta_{V0}$ -factor	[mm/(kN)]	0,02	0,02	0,01	0,01	0,01	0,01
	$\delta_{V\infty}$ -factor	[mm/(kN)]	0,03	0,02	0,02	0,01	0,01	0,01

<sup>1)</sup> Calculation of the displacement

$$\delta_{V0} = \delta_{V0\text{-factor}} \cdot V;$$

$$\delta_{V\infty} = \delta_{V\infty\text{-factor}} \cdot V;$$

**Injection system for concrete  
Fix Master FIT-Pe 270, Fix Master FIT-Px 270, Fix Master FIT-Pt 270**

**Performances**  
Displacement

**Annex C 3**